



Seating for Activity-Based Working: *For the 21st century workspace.*



Custom colours. Quick delivery. Exceptional value. Australian made quality.

The changing way of work

The way we work in Australia is changing, which is why many offices are complementing their traditional cubicle or hot-desk set-ups with activity-based working (ABW).

We offer a range of ABW Seating to meet the needs of the modern Australian organisation - from communal breakout lounges to semi-private pods for focused work.

Stylish, flexible and incredibly cost effective, ABW Seating is the smart choice for the 21st-century business.





PROUDLY
AUSTRALIAN
MADE



The new kind of workplace seating











Our selection of ABW Seating is built for flexibility, efficiency and style.

Featuring a range of booths, lounges, ottomans, focus pods and visitor chairs, our activity-based modules can be combined and customised to meet the diverse needs of any modern-day enterprise.

The seats are soft, supportive and available in a variety of colours, from classic blacks and greys to vibrant reds, greens and blues. Businesses can even supply their own fabric for the ultimate in custom seating.

Cost-effective, functional, and with a healthy dose of originality, ABW Seating helps 21st-century businesses create a 21st-century workspace.

- ✓ Contemporary styles to suit the modern office fit-out
- ✓ Covered in soft-yet-sturdy fabric with a subtle linen weave
- ✓ Mix and match from striking house fabric colours, or BYO fabric to match your existing decor
- ✓ Customised configurations to meet the needs of any business
- ✓ Manufactured in Australia, with a six week lead time

	Amee.....Page 6		Flix Standard.....Page 24 Flix Tall Page 26
	KhloePage 8		Flo Standard..... Page 28 Flo Tall..... Page 30
	Yara Standard Page 10 Yara Tall Page 12		Zig..... Page 32
	Zara..... Page 14		Harper Page 34
	Pebble..... Page 16		Archer Page 36
	Otto..... Page 18		Laptop Table Page 38
	Park Standard..... Page 20 Park Tall..... Page 22		

Valuable & Flexible Fit-outs

ABW Seating adds value to a space. It is easy to move, can be combined with traditional workstations and gives you the flexibility to alter your office space as your project or workforce changes.

Collaboration

Improves collaboration and knowledge sharing – teams can have a catch-up in a pod or breakout area, in addition to formal meeting rooms.

Concentration

Enhances concentration for focused tasks. Open-plan offices are great, but some people find background noise distracting. Providing 'focus rooms' lets staff have a quiet space for tasks that require serious concentration.

Benefits of an activity-based workplace

Attract & Retain Staff

Empowers Staff

Active Employees

Collaboration

Valuable & Flexible Fitouts

Concentration

More Active Employees

Moving between areas depending on their current task means staff are less sedentary during the day. That encourages better health and can reduce sick days.

Attract and Retain Staff

Activity-based working is fast becoming a major selling point for recruitment. Increased choice, better interactions with colleagues and a more appealing office environment improves employee satisfaction and helps businesses attract and retain staff.

Empowers Staff

We all have different needs and preferences around our working habits. Activity-based working recognises this and lets staff decide how and where they work best for each task.

Amee

Amee is a comfortable, flexible and versatile soft seating solution where employees can escape workplace distractions. Boasting a creative form, Amee is characterised by unique wings that function as a quiet space for thoughtful deliberation and focused discussion. Stylish 120mm chrome feet further enhance its appeal.

Feature Highlights

- Available in any fabric to suit your colour scheme
- Popular range of booth seating
- Modern 120mm chrome feet



1 Seater Booth

Amee

Code	Description	External (mm)			Seat (mm)		Meterage
		Height	Width	Depth	Height	Depth	
AMEET1	Amee 1 Seater Booth	1170	740	770	450	500	7
AMEET2	Amee 2 Seater Booth	1170	1340	770	450	500	8
AMEET2.5	Amee 2.5 Seater Booth	1170	1640	770	450	500	9
AMEET3	Amee 3 Seater Booth	1170	1940	770	450	500	10



2 Seater Booth



2.5 Seater Booth



3 Seater Booth

Amee Range

Fabric A Fabric B

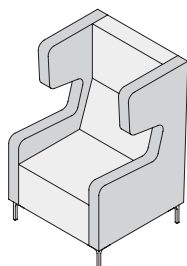

1 Seater
AMEET1

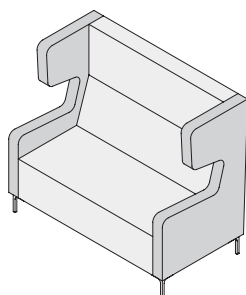

2 Seater
AMEET2

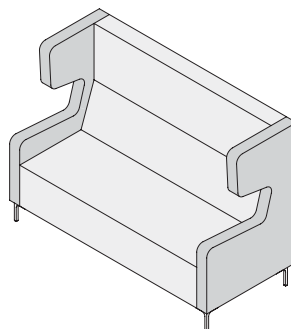

2.5 Seater
AMEET2.5

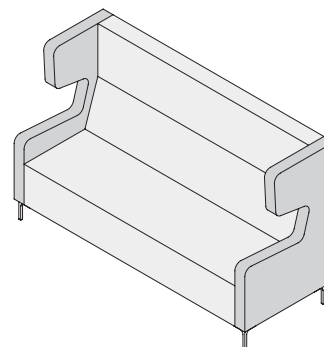

3 Seater
AMEET3

Note: Custom two-tone upholstery orders (outside the standard two-tone specifications) may incur an additional charge.

Khloe

The acoustically designed Khloe features wings on either side and overhead. This innovative design is teamed with 120mm high chrome feet and ensures Khloe is visually striking and equally serviceable as a private setting to place an important call or hold an uninterrupted discussion.

Feature Highlights

- Available in any fabric to suit your colour scheme
- Booth seating
- Acoustic wings offer a private setting



1 Seater Booth

Khloe

Code	Description	External (mm)			Seat (mm)		Meterage
		Height	Width	Depth	Height	Depth	
KHLOE1SLW	Khloe 1 Seater Booth	1570	700	710	450	520	9.1
KHLOE2SLW	Khloe 2 Seater Booth	1570	1350	710	450	520	11.1
KHLOE2.5SLW	Khloe 2.5 Seater Booth	1570	1550	710	450	520	13.5



2 Seater Booth



2.5 Seater Booth

Khloe Range

Fabric A Fabric B

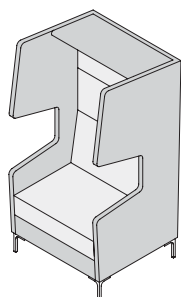

1 Seater
KHLOE1SLW

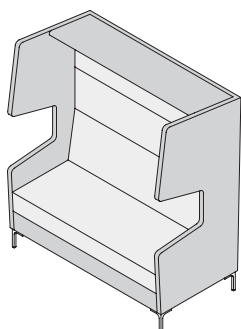

2 Seater
KHLOE2SLW

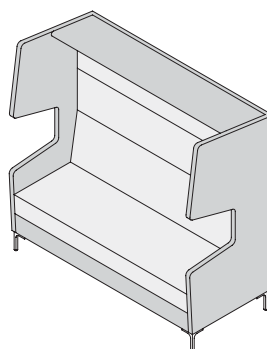

2.5 Seater
KHLOE2.5SLW

Note: Custom two-tone upholstery orders (outside the standard two-tone specifications) may incur an additional charge.

Yara Standard

The cleverly designed Yara offers the mobility demanded of activity-based work whilst allowing for privacy. The Yara sits proudly on 120mm high chrome feet and is offered in two back heights for added flexibility. The standard back defines a place to work or relax, whilst the tall back provides added privacy for an important conversation or solitary concentration.

Feature Highlights

- Available in 2 tone fabric scheme
- Acoustic properties of design
- Optional power & usb port available

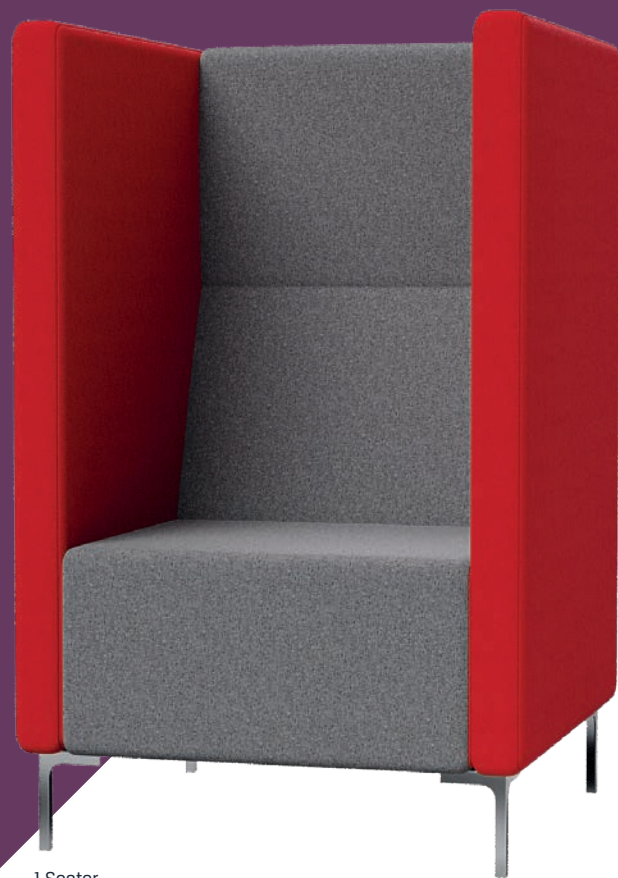

1 Seater

Yara Standard

Code	Description	External (mm)			Seat (mm)		Meterage
		Height	Width	Depth	Height	Depth	
YARASB1	Yara Standard Back 1 Seater	1200	750	760	450	520	6.3
YARASB2	Yara Standard Back 2 Seater	1200	1350	760	450	520	7.7
YARASB2.5	Yara Standard Back 2.5 Seater	1200	1650	760	450	520	8.6
YARASB3	Yara Standard Back 3 Seater	1200	1950	760	450	520	10.2



2 Seater



2.5 Seater

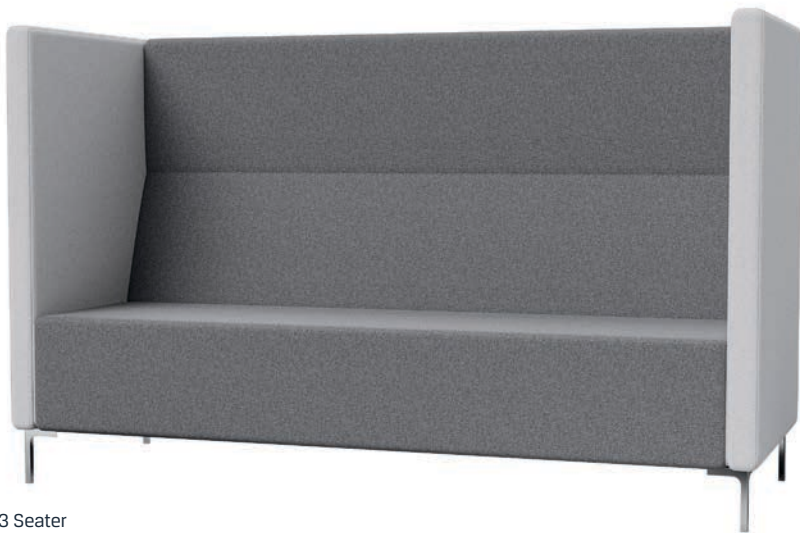

3 Seater

Yara Standard Range

Fabric A Fabric B

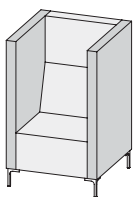

1 Seater
YARASB1

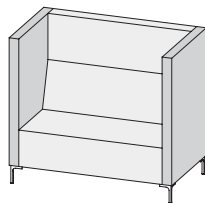

2 Seater
YARASB2

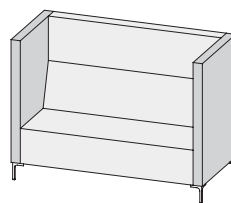

2.5 Seater
YARASB2.5

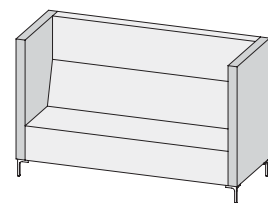

3 Seater
YARASB3

Note: Custom two-tone upholstery orders (outside the standard two-tone specifications) may incur an additional charge.

Yara Tall

The cleverly designed Yara offers the mobility demanded of activity-based work whilst allowing for privacy. The Yara sits proudly on 120mm high chrome feet and is offered in two back heights for added flexibility. The standard back defines a place to work or relax, whilst the tall back provides added privacy for an important conversation or solitary concentration.

Feature Highlights

- Available in 2 tone fabric scheme
- Acoustic properties of design
- Optional power & usb port available



1 Seater

Yara Tall

Code	Description	External (mm)			Seat (mm)		Meterage
		Height	Width	Depth	Height	Depth	
YARATB1	Yara Tall Back 1 Seater	1600	750	760	450	520	8.5
YARATB2	Yara Tall Back 2 Seater	1600	1350	760	450	520	10.0
YARATB2.5	Yara Tall Back 2.5 Seater	1600	1650	760	450	520	12.0
YARATB3	Yara Tall Back 3 Seater	1600	1950	760	450	520	12.7



2 Seater



2.5 Seater



3 Seater

Yara Tall Range

Fabric A Fabric B

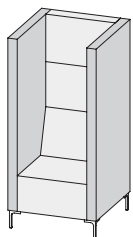

1 Seater
YARATB1

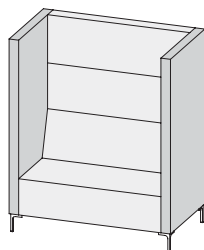

2 Seater
YARATB2

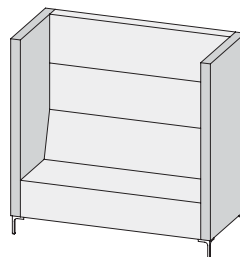

2.5 Seater
YARATB2.5

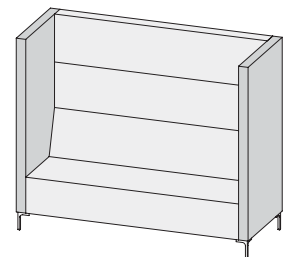

3 Seater
YARATB3

Note: Custom two-tone upholstery orders (outside the standard two-tone specifications) may incur an additional charge.

Zara

The contemporary design of Zara is paired with sturdy wooden feet to create a homely comfort factor that will extend a warm welcome in a reception or executive offices. Stand Zara alone as a cosy place to pass time, or pair to create a relaxed atmosphere for one-to-one conversation.

Feature Highlights

- Available in any fabric to suit your colour scheme
- Versatile standalone office chair
- Unique wooden feet



1 Seater Booth

Zara

Code	Description	External (mm)			Seat (mm)		Meterage
		Height	Width	Depth	Height	Depth	
ZARA1S	Zara 1 Seater Booth	1100	850	750	450	520	6
ZARA2S	Zara 2 Seater Booth	1100	1500	750	450	520	8



2 Seater Booth

Zara Range

Fabric A Fabric B

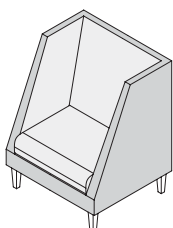

1 Seater
ZARA1S

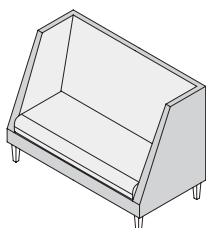

2 Seater
ZARA2S

Note: Custom two-tone upholstery orders (outside the standard two-tone specifications) may incur an additional charge.

Pebble

Pebble is a functional ottoman in an inspired form, that is ideal for workplaces aspiring to a creative vibe. Designed for comfort, the Pebble uses little floor space and is easily moved to quickly adapt to Australians ever-changing work days.

Feature Highlights

- Select a fabric colour to match existing furniture
- Superior quality, top stitched
- Create quick seating options

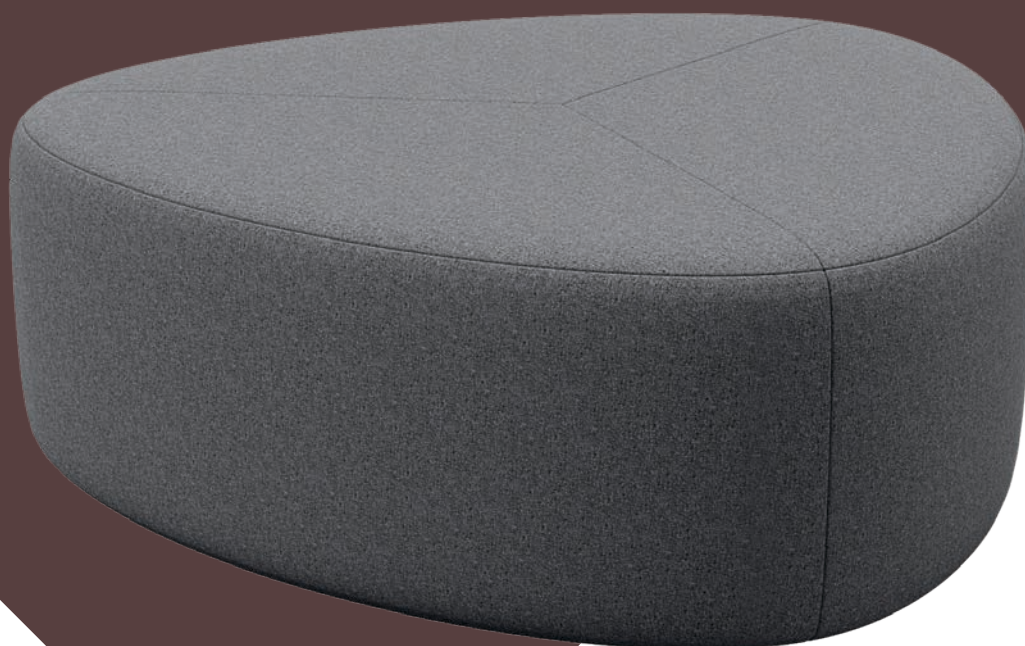

Ottoman
1200mm wide

Pebble

Code	Description	External (mm)			Seat (mm)		Meterage
		Height	Width	Depth	Height	Depth	
PEBBLESEAT	Pebble Highrise Seat 450mm wide	650	450	450	650	450	1.3
PEBBLE450W	Pebble Ottoman 450mm wide	450	450	450	450	450	0.8
PEBBLE600W	Pebble Ottoman 600mm wide	450	600	600	450	600	1.3
PEBBLE900W	Pebble Ottoman 900mm wide	450	900	900	450	900	1.9
PEBBLE1200W	Pebble Ottoman 1200mm wide	450	1200	1200	450	1200	3.2
PEBBLE1500W	Pebble Ottoman 1500mm wide	450	1500	1500	450	1500	4.6



PROUDLY AUSTRALIAN MADE



Highrise Seat 450mm wide

Ottoman 450mm wide

Ottoman 900mm wide

Ottoman 1500mm wide

Ottoman 600mm wide

Pebble Range

Fabric A

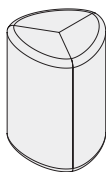

Highrise Seat
PEBBLESEAT

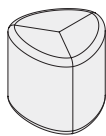

Ottoman 450mm
PEBBLE450W

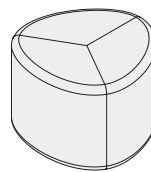

Ottoman 600mm
PEBBLE600W

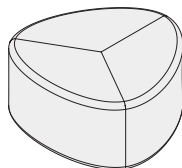

Ottoman 900mm
PEBBLE900W

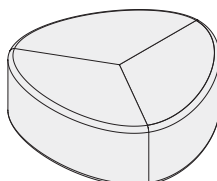

Ottoman 1200mm
PEBBLE1200W

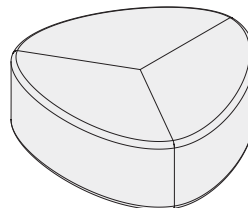

Ottoman 1500mm
PEBBLE1500W

Note: Two-tone fabric is unavailable for the Pebble range.

Otto

Otto is a simple and versatile solution to supplement workspaces. The round single seats are easily portable, whilst larger options make a striking centre piece and casual meeting place for work teams. Alternatively, add a back for comfortable breakout seating around workstations.

Feature Highlights

- Round or curved shape
- Option to add a back
- Available in any fabric to suit your colour scheme

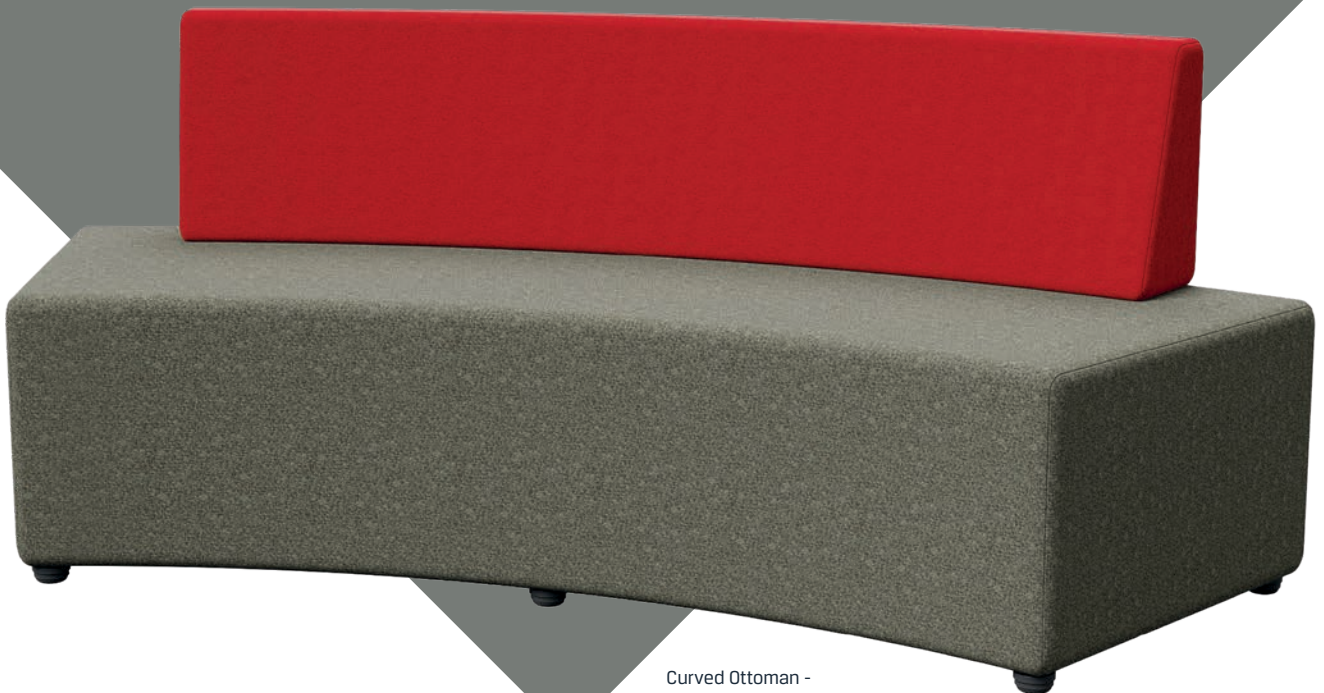

Curved Ottoman -
Seat & Back 2100mm diameter

Otto – Mix Round

Code	Description	External (mm)			Seat (mm)		Meterage
		Height	Width	Depth	Height	Depth	
OTTOMIXROUND450DIA	Otto Mix Round - 450mm dia	450	450	450	450	450	1.5
OTTOMIXROUND500DIA	Otto Mix Round - 500mm dia	450	500	500	450	500	1.5
OTTOMIXROUND600DIA	Otto Mix Round - 600mm dia	450	600	600	450	600	1.7
OTTOMIXROUND600DIA-BT	Otto Mix Round - 600mm dia - Bite	450	600	600	450	600	1.7
OTTOMIXROUND900DIA	Otto Mix Round - 900mm dia	450	900	900	450	900	3.0
OTTOMIXROUND1200DIA	Otto Mix Round - 1200mm dia	450	1200	1200	450	1200	3.7
OTTOMIXROUND1500DIA	Otto Mix Round - 1500mm dia	450	1500	1500	450	1500	5.0



Curved Ottoman -
Seat Only 1200mm diameter



Round Ottoman -
1200mm diameter



Curved Ottoman -
Seat & Back 1500mm diameter

Otto Range

 Fabric A  Fabric B

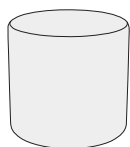

Round Ottoman
OTTOMIXROUND450DIA

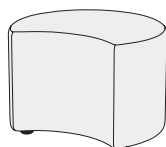

Round Ottoman Bite
OTTOMIXROUND600DIA-BT

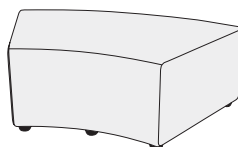

Curved Ottoman
OTTOMIXCURVE1200S

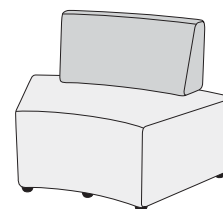

Curved Ottoman Seat & Back
OTTOMIXCURVE1200SB

Otto – Mix Curved

Code	Description	External (mm)			Seat (mm)		Meterage
		Height	Width	Depth	Height	Depth	
OTTOMIXCURVE1200S	Otto Mix Curved - Seat Only 1200mm dia	450	1200	770/700	450	700	2.6
OTTOMIXCURVE1500S	Otto Mix Curved - Seat Only 1500mm dia	450	1500	800/700	450	700	3.2
OTTOMIXCURVE1800S	Otto Mix Curved - Seat Only 1800mm dia	450	1800	830/700	450	700	4
OTTOMIXCURVE2100S	Otto Mix Curved - Seat Only 2100mm dia	450	2100	860/700	450	700	4.6
OTTOMIXCURVE2400S	Otto Mix Curved - Seat Only 2400mm dia	450	2400	890/700	450	700	5.3
OTTOMIXCURVE2700S	Otto Mix Curved - Seat Only 2700mm dia	450	2700	920/700	450	700	5.8
OTTOMIXCURVE1200SB	Otto Mix Curved - Seat & Back 1200mm dia	820	1200	770/700	450	500	3.9
OTTOMIXCURVE1500SB	Otto Mix Curved - Seat & Back 1500mm dia	820	1500	800/700	450	500	4.8
OTTOMIXCURVE1800SB	Otto Mix Curved - Seat & Back 1800mm dia	820	1800	830/700	450	500	5.9
OTTOMIXCURVE2100SB	Otto Mix Curved - Seat & Back 2100mm dia	820	2100	860/700	450	500	6.8
OTTOMIXCURVE2400SB	Otto Mix Curved - Seat & Back 2400mm dia	820	2400	890/700	450	500	7.8
OTTOMIXCURVE2700SB	Otto Mix Curved - Seat & Back 2700mm dia	820	2700	920/700	450	500	8.6

Note: Custom two-tone upholstery orders (outside the standard two-tone specifications) may incur an additional charge.

Park Standard

The versatility of Park make it the perfect seating option for breakout spaces and ad-hoc meeting areas. Featuring a smooth aesthetic design and clever modular construction, Park offers multiple configurations to inspire imaginative workplaces. Position Park in a circle to define a team meeting area, or use independently by adding arms, a laptop table and a matching ottoman.

Feature Highlights

- Versatile & modular layout
- Smooth aesthetic design
- Option to add arms & matching ottoman



1.5 Seater Inner-Curve Standard Back (45 degree)

Park Standard

Code	Description	External (mm)			Seat (mm)		Meterage
		Height	Width	Depth	Height	Depth	
PARK1S30DEGCO	Park 1 Seater Outer-Curve Ottoman (30°)	450	900/500	740	450	740	2.4
PARK1.5S45DEGCO	Park 1.5 Seater Outer-Curve Ottoman (45°)	450	1300/750	740	450	740	3.1
PARK1SSB	Park 1 Seater Standard Back	770	650	740	450	555	2.5
PARK2SSB	Park 2 Seater Standard Back	770	1300	740	450	555	3.8
PARK1S30DEGCIB	Park 1 Seater Inner-Curve Standard Back (30°)	770	900/500	740	450	555	2.6
PARK1S30DEGCOB	Park 1 Seater Outer-Curve Standard Back (30°)	770	900/500	740	450	555	3.2
PARK1.5S45DEGCIB	Park 1.5 Seater Inner-Curve Standard Back (45°)	770	1300/750	740	450	555	3.4
PARK1.5S45DEGCOB	Park 1.5 Seater Outer-Curve Standard Back (45°)	770	1300/750	740	450	555	4.6
PARK1SCNRRH	Park Corner Seater Standard Back - Right Hand	770	770	740	450	555	3.6
PARK1SCNRLH	Park Corner Seater Standard Back - Left Hand	770	770	740	450	555	3.6
PARK1SSO	Park Ottoman 650mm	450	650	740	450	740	2.2
PARK2SSO	Park Ottoman 1300mm	450	1300	740	450	740	3.3
PARKSBHUD6S	Park Standard Huddle - 6 Seater	770	3400	3030	450	555	26
PARKSBHUDA6S	Park Standard Huddle - With Arms - 6 Seater	770	3400	3150	450	555	28.2
PARKSBHUD9S	Park Standard Huddle - 9 Seater	770	4050	4330	450	555	36.1
PARKSBHUDA9S	Park Standard Huddle - With Arms - 9 Seater	770	4050	4460	450	555	38.3
PARKSBARC3S	Park Standard Arc - 3 Seater	770	3150	1360	450	555	13.8
PARKSBARC6S	Park Standard Arc - 6 Seater	770	3400	2910	450	555	27.6
PARKSBARC7S	Park Standard Arc - 7 Seater	770	3400	3400	450	555	32.2
PARKSBARC8S	Park Standard Arc - 8 Seater	770	3400	3400	450	555	27.2
PARKSBWAV6S	Park Standard Wave - 6 Seater	770	6130	1550	450	555	25.2

Park Standard Range

Fabric A Fabric B

PROUDLY
AUSTRALIAN
MADE

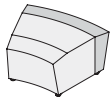

1 Seater Outer-Curve Ottoman
(30 degree)
PARK1S30DEGCO

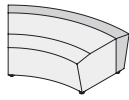

1.5 Seater Outer-Curve Ottoman
(45 degree)
PARK1.5S45DEGCO

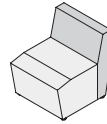

1 Seater Standard Back
PARK1SSB

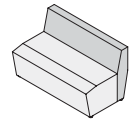

2 Seater Standard Back
PARK2SSB

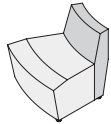

1 Seater Inner-Curve Standard Back
(30 degree)
PARK1S30DEGCIB

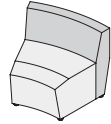

1 Seater Outer-Curve Standard Back
(30 degree)
PARK1S30DEGCOB



1.5 Seater Inner-Curve Standard
Back (45 degree)
PARK1.5S45DEGCIB

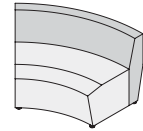

1.5 Seater Outer-Curve Standard
Back (45 degree)
PARK1.5S45DEGCOB

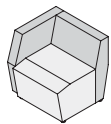

Corner Seater Standard Back -
Right Hand
PARK1SCNRRH

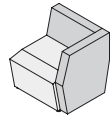

Corner Seater Standard Back -
Left Hand
PARK1SCNRLH

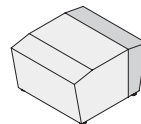

Ottoman 650mm
PARK1SSO

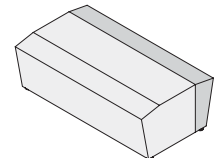

Ottoman 1300mm
PARK2SSO

Configuration Options



Huddle - 6 Seater
PARKSBHUD6S



Huddle - 6 Seater - With Arms
PARKSBHUDA6S

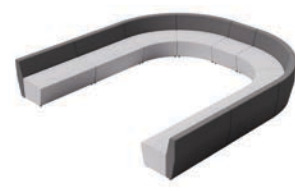

Huddle - 9 Seater
PARKSBHUD9S

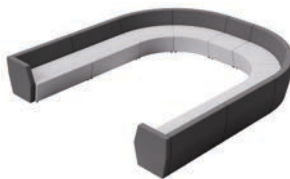

Huddle - 9 Seater - With Arms
PARKSBHUDA9S



Arc - 3 Seater
PARKSBARC3S

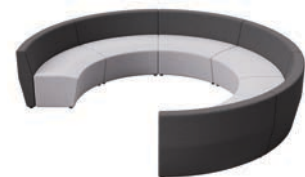

Arc - 6 Seater
PARKSBARC6S



Arc - 7 Seater
PARKSBARC7S

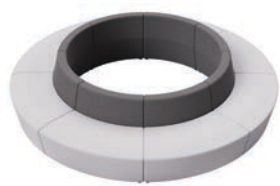

Arc - 8 Seater
PARKSBARC8S



Wave - 6 Seater
PARKSBWAV6S

Note: Custom two-tone upholstery orders (outside the standard two-tone specifications) may incur an additional charge.

Park Tall

For added privacy, extra back and neck support, and comfort, the Park is also available in a tall version. The height of the back provides a semi-enclosed, cocoon type working environment enabling persons to have 'their own space' amongst a busy workplace. The taller version is ideal for activities requiring heightened focus and concentration, or even phone discussions.

Feature Highlights

- Versatile & modular layout
- Smooth aesthetic design
- Option to add arms & matching ottoman



1.5 Seater Inner-Curve Tall Back (45 degree)

Park Tall

Code	Description	External (mm)			Seat (mm)		Meterage
		Height	Width	Depth	Height	Depth	
PARK1SSTB	Park 1 Seater Tall Back	1110	650	740	450	555	3.5
PARK2SSTB	Park 2 Seater Tall Back	1110	1300	740	450	555	5.3
PARK1S30DEGCITB	Park 1 Seater Inner-Curve Tall Back (30°)	1110	900/500	740	450	555	3.6
PARK1S30DEGCOTB	Park 1 Seater Outer-Curve Tall Back (30°)	1110	900/500	740	450	555	4.2
PARK1.5S45DEGCITB	Park 1.5 Seater Inner-Curve Tall Back (45°)	1110	1320/750	740	450	555	4.4
PARK1.5S45DEGCOTB	Park 1.5 Seater Outer-Curve Tall Back (45°)	1110	1320/750	740	450	555	6
PARK1SCNRRHTB	Park Corner Seater Tall-Back - Right Hand	1110	760	740	450	555	5.6
PARK1SCNRLHTB	Park Corner Seater Tall-Back - Left Hand	1110	760	740	450	555	5.6
PARK1SSO	Park Ottoman 650mm	450	650	740	450	740	2.2
PARK2SSO	Park Ottoman 1300mm	450	1300	740	450	740	3.3
PARKTBHUD6S	Park Tall Huddle - 6 Seater	1110	3400	3030	450	555	34.6
PARKTBHUDA6S	Park Tall Huddle - With Arms - 6 Seater	1110	3400	3150	450	555	38.8
PARKTBHUD9S	Park Tall Huddle - 9 Seater	1110	4050	4330	450	555	48.7
PARKTBHUDA9S	Park Tall Huddle - With Arms - 9 Seater	1110	4050	4460	450	555	52.9
PARKTBARC3S	Park Tall Arc - 3 Seater	1110	3150	1360	450	555	18
PARKTBARC6S	Park Tall Arc - 6 Seater	1110	3400	2910	450	555	36
PARKTBARC7S	Park Tall Arc - 7 Seater	1110	3400	3400	450	555	42
PARKTBARC8S	Park Tall Arc - 8 Seater	1110	3400	3400	450	555	35.2
PARKTBWAV6S	Park Tall Wave - 6 Seater	1110	6130	1550	450	555	32.8

Park Tall Range

Fabric A Fabric B Fabric C

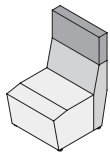

1 Seater Tall Back
PARK1S1STB

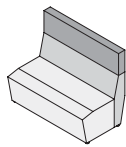

2 Seater Tall Back
PARK2S1STB

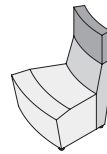

1 Seater Inner-Curve Tall Back
(30 degree)
PARK1S30DEGC1TB

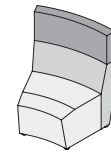

1 Seater Outer-Curve Tall Back
(30 degree)
PARK1S30DEGC0TB

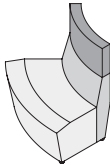

1.5 Seater Inner-Curve Tall Back
(45 degree)
PARK1.5S45DEGC1TB

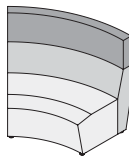

1.5 Seater Outer-Curve Tall Back
(45 degree)
PARK1.5S45DEGC0TB

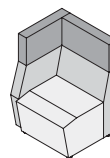

Corner Seater Tall-Back - Right Hand
PARK1SCNRRHTB

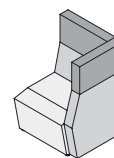

Corner Seater Tall-Back - Left Hand
PARK1SCNRLHTB

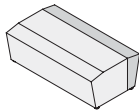

Ottoman 1300mm
PARK2SS0

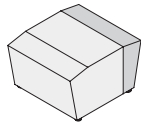

Ottoman 650mm
PARK1SS0

Configuration Options



Huddle - 6 Seater
PARKTBHUD6S



Huddle - 6 Seater - With Arms
PARKTBHUDA6S

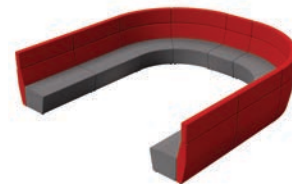

Huddle - 9 Seater
PARKTBHUD9S



Huddle - 9 Seater - With Arms
PARKTBHUDA9S



Arc - 3 Seater
PARKTBARC3S



Arc - 6 Seater
PARKTBARC6S



Arc - 7 Seater
PARKTBARC7S

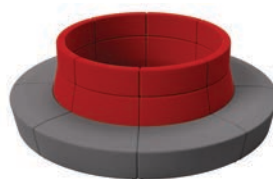

Arc - 8 Seater
PARKTBARC8S



Wave - 6 Seater
PARKTBWAV6S

Note: Custom two-tone upholstery orders (outside the standard two-tone specifications) may incur an additional charge.

Flix Standard

Flix comprises modular seating in straight, curved and round shapes to inspire creativity, conversation and collaboration. Choose to add rectangular shaped arms and tall backs to enclose spaces where teams can huddle. Alternatively, combine curved modules into an endless wave for a fun, imaginative and social setting. The addition of optional matching ottomans completes the space.

Feature Highlights

- Large range of modular configuration options for; Booth Seating, Banquet Seating, Arena Seating & Huddle spaces
- Option to add rectangular shaped arms and matching ottoman



1 Seater Curved INNER Standard Back

Flix Standard

Code	Description	External (mm)			Seat (mm)		Meterage
		Height	Width	Depth	Height	Depth	
FLIXBCNR	Flix Corner Seater Standard Back	780	710	710	450	500	4
FLIXB1S	Flix 1 Seater Standard Back	780	600	710	450	500	3.2
FLIXB2S	Flix 2 Seater Standard Back	780	1200	710	450	500	3.9
FLIXB2.5S	Flix 2.5 Seater Standard Back	780	1500	710	450	500	4.4
FLIXB3S	Flix 3 Seater Standard Back	780	1800	710	450	500	5.1
FLIXB4S	Flix 4 Seater Standard Back	780	2400	710	450	500	9
FLIXSB45DEGC0B	Flix 1 Seater Curved OUTER Standard Back	780	1045/500	710	450	500	5
FLIXSB45DEGCIB	Flix 1 Seater Curved INNER Standard Back	780	1045/500	710	450	500	3.8
FLIXSBARM	Flix Arm (Single) to Suit 780 High	780	90	710	450	n/a	1.6
FLIXOTTO7160	Flix Ottoman	450	600	710	450	710	2.5
FLIXOTTO45DEGC	Flix Ottoman 45° Curved	450	1080/530	710	450	710	3.2
FLIXOTTO90DEGC	Flix Ottoman 90° Curved	450	2010/1000	710	450	710	4.9
FLIXSBHUD6S	Flix Standard Huddle - 6 Seater	780	2780	2620	450	500	27.8
FLIXSBHUDA6S	Flix Standard Huddle - w/ Arms - 6 Seater	780	2780	2710	450	500	31
FLIXSBHUD7S	Flix Standard Huddle - 7 Seater	780	2670	2560	450	500	22.1
FLIXSBHUDA7S	Flix Standard Huddle - w/ Arms - 7 Seater	780	2670	2650	450	500	25.3
FLIXSBHUD9S	Flix Standard Huddle - 9 Seater	780	3380	3820	450	500	38.8
FLIXSBHUDA9S	Flix Standard Huddle - w/ Arms - 9 Seater	780	3380	3910	450	500	42
FLIXSBARC3S	Flix Standard Arc - 3 Seater	780	2570	1160	450	500	15
FLIXSBARC6S	Flix Standard Arc - 6 Seater	780	2780	2380	450	500	30
FLIXSBARC7S	Flix Standard Arc - 7 Seater	780	2780	2780	450	500	35
FLIXSBARC8S	Flix Standard Arc - 8 Seater	780	2780	2780	450	500	30.4
FLIXSBWAV6S	Flix Standard Wave - 6 Seater	780	4840	1350	450	500	27.6

Flix Standard Range

Fabric A Fabric B

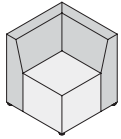

Corner Seater Standard Back
FLIXSBCNR

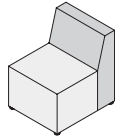

1 Seater Standard Back
FLIXSB1S

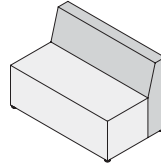

2 Seater Standard Back
FLIXSB2S

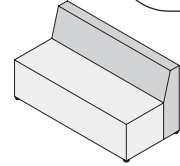

2.5 Seater Standard Back
FLIXSB2.5S

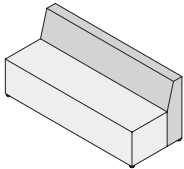

3 Seater Standard Back
FLIXSB3S

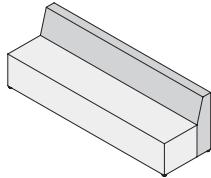

4 Seater Standard Back
FLIXSB4S

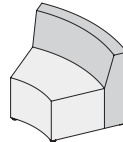

1 Seater Curved OUTER
Standard Back
FLIXSB45DEGC0B

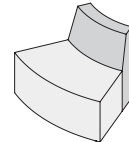

1 Seater Curved INNER
Standard Back
FLIXSB45DEGC1B

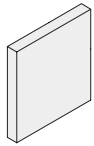

Arm (Single) to Suit 780 High
FLIXSBARM

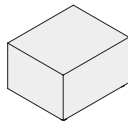

Ottoman
FLIXOTT07160

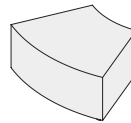

Flix Ottoman 45 Degree Curved
FLIXOTT045DEGC

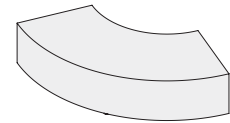

Flix Ottoman 90 Degree Curved
FLIXOTT090DEGC

Configuration Options



Huddle - 6 Seater
FLIXSBHUD6S



Huddle - 6 Seater - With Arms
FLIXSBHUDA6S



Huddle - 7 Seater
FLIXSBHUD7S



Huddle - 7 Seater - With Arms
FLIXSBHUDA7S



Huddle - 9 Seater
FLIXSBHUD9S



Huddle - 9 Seater - With Arms
FLIXSBHUDA9S



Arc - 3 Seater
FLIXSBARC3S



Arc - 6 Seater
FLIXSBARC6S



Arc - 7 Seater
FLIXSBARC7S



Arc - 8 Seater
FLIXSBARC8S



Wave - 6 Seater
FLIXSBWA6S

Note: Custom two-tone upholstery orders (outside the standard two-tone specifications) may incur an additional charge.

Flix Tall

For added privacy, extra back and neck support, and comfort, the Flix is also available in a tall version. The height of the back provides a semi-enclosed, cocoon type working environment enabling persons to have 'their own space' amongst a busy workplace. The taller version is ideal for activities requiring heightened focus and concentration, or even phone discussions.

Feature Highlights

- Large range of modular configuration options for; Booth Seating, Banquet Seating, Arena Seating & Huddle spaces
- Option to add rectangular shaped arms and matching ottoman



1 Seater Curved OUTER Tall Back

Flix Tall

Code	Description	External (mm)			Seat (mm)		Meterage
		Height	Width	Depth	Height	Depth	
FLIXTBCNR	Flix Corner Seater Tall Back	1200	710	710	450	500	5.3
FLIXTB1S	Flix 1 Seater Tall Back	1200	600	710	450	500	4.2
FLIXTB2S	Flix 2 Seater Tall Back	1200	1200	710	450	500	5.6
FLIXTB2.5S	Flix 2.5 Seater Tall Back	1200	1500	710	450	500	6.4
FLIXTB3S	Flix 3 Seater Tall Back	1200	1800	710	450	500	7.4
FLIXTB4S	Flix 4 Seater Tall Back	1200	2400	710	450	500	8.6
FLIXTB45DEGCOB	Flix 1 Seater Curved OUTER Tall Back	1200	1045/500	710	450	500	4.7
FLIXTB45DEGCIB	Flix 1 Seater Curved INNER Tall Back	1200	1045/500	710	450	500	3.8
FLIXTBARM	Flix Arm (Single) to Suit 1200 High	1200	90	710	450	n/a	1.6
FLIXOTTO7160	Flix Ottoman	450	600	710	450	710	2.5
FLIXOTTO45DEGC	Flix Ottoman 45° Curved	450	1080/530	710	450	710	3.2
FLIXOTTO90DEGC	Flix Ottoman 90° Curved	450	2010/1000	710	450	710	4.9
FLIXTBHUD6S	Flix Tall Huddle - 6 Seater	1200	2780	2620	450	500	30
FLIXTBHUDA6S	Flix Tall Huddle - With Arms - 6 Seater	1200	2780	2710	450	500	33.2
FLIXTBHUD7S	Flix Tall Huddle - 7 Seater	1200	2670	2560	450	500	31
FLIXTBHUDA7S	Flix Tall Huddle - With Arms - 7 Seater	1200	2670	2650	450	500	34.2
FLIXTBHUD9S	Flix Tall Huddle - 9 Seater	1200	3380	3820	450	500	45.4
FLIXTBHUDA9S	Flix Tall Huddle - With Arms - 9 Seater	1200	3380	3910	450	500	48.6
FLIXTBARC3S	Flix Tall Arc - 3 Seater	1200	2570	1160	450	500	14.1
FLIXTBARC6S	Flix Tall Arc - 6 Seater	1200	2780	2380	450	500	28.2
FLIXTBARC7S	Flix Tall Arc - 7 Seater	1200	2780	2780	450	500	32.9
FLIXTBARC8S	Flix Tall Arc - 8 Seater	1200	2780	2780	450	500	30.4
FLIXTBWAV6S	Flix Tall Wave - 6 Seater	1200	4840	1350	450	500	26.4

Flix Tall Range

Fabric A Fabric B

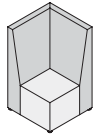

Corner Seater Tall Back
FLIXTBCNR

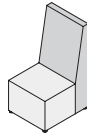

1 Seater Tall Back
FLIXTB1S

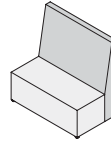

2 Seater Tall Back
FLIXTB2S

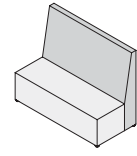

2.5 Seater Tall Back
FLIXTB2.5S

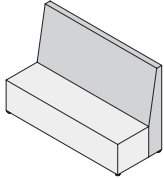

3 Seater Tall Back
FLIXTB3S

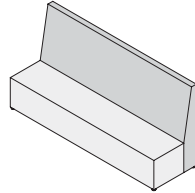

4 Seater Tall Back
FLIXTB4S

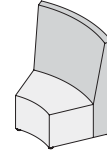

1 Seater Curved OUTER Tall Back
FLIXTB45DEGCOB

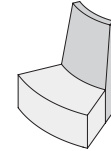

1 Seater Curved INNER Tall Back
FLIXTB45DEGCIB

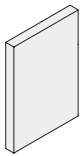

Arm (Single) to Suit 1200 High
FLIXTBARM

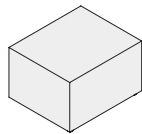

Ottoman
FLIXOTT07160

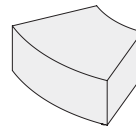

Flix Ottoman 45 Degree Curved
FLIXOTT045DEGC

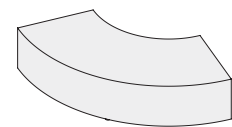

Flix Ottoman 90 Degree Curved
FLIXOTT090DEGC

Configuration Options



Huddle - 6 Seater
FLIXTBHUD6S



Huddle - 6 Seater - With Arms
FLIXTBHUDA6S



Huddle - 7 Seater
FLIXTBHUD7S



Huddle - 7 Seater - With Arms
FLIXTBHUDA7S



Huddle - 9 Seater
FLIXTBHUD9S



Huddle - 9 Seater - With Arms
FLIXTBHUDA9S



Arc - 3 Seater
FLIXTBARC3S



Arc - 6 Seater
FLIXTBARC6S



Arc - 7 Seater
FLIXTBARC7S



Arc - 8 Seater
FLIXTBARC8S



Wave - 6 Seater
FLIXTBWAV6S

Note: Custom two-tone upholstery orders (outside the standard two-tone specifications) may incur an additional charge.

Flo Standard

Flo modular seating is ideally formed in a large sitting area where teams work, relax or collaborate. Flo is an eye-catching design mounted on 120mm high chrome feet that shouts creativity. The standard back option with the addition of a matching ottoman provides an open invitation for group collaboration. The tall back alternative forms creative hubs for added seclusion, concentration and privacy.

Feature Highlights

- Large range of modular configuration options
- Options to add rectangular shaped arms and matching ottoman
- Modern design with 120mm high feet

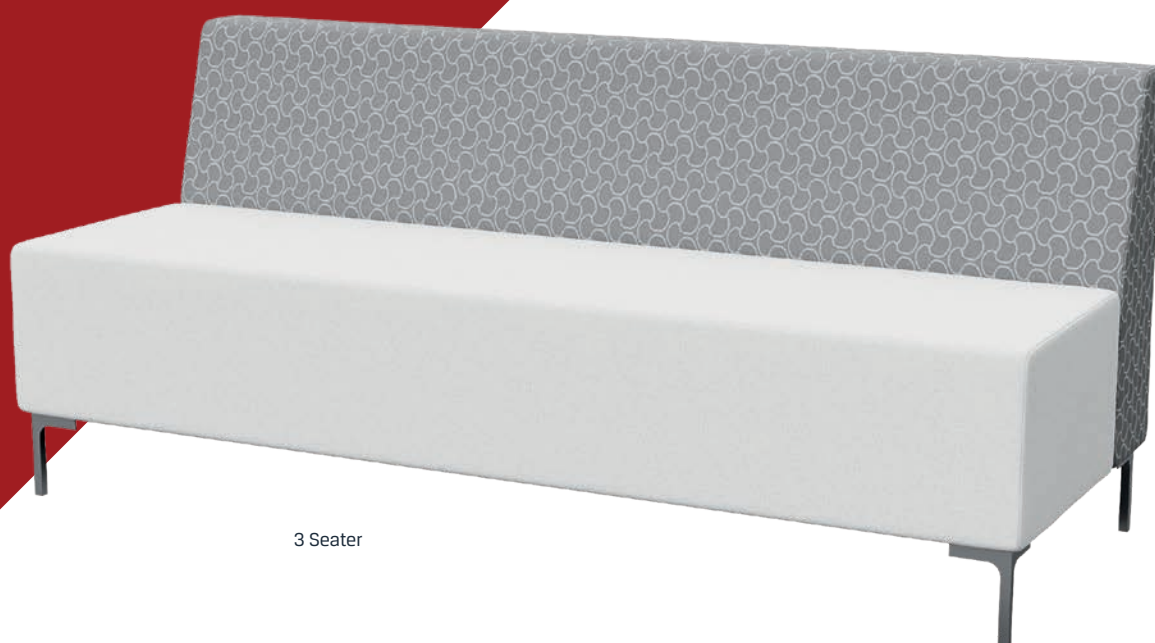

3 Seater

Flo Standard

Code	Description	External (mm)			Seat (mm)		Meterage
		Height	Width	Depth	Height	Depth	
FLO1	Flo 1 Seater Standard Back	780	600	710	450	500	2.2
FLO2	Flo 2 Seater Standard Back	780	1200	710	450	500	2.9
FLO2.5	Flo 2.5 Seater Standard Back	780	1500	710	450	500	3.4
FLO3	Flo 3 Seater Standard Back	780	1800	710	450	500	4.1
FLO4	Flo 4 Seater Standard Back	780	2400	710	450	500	8
FLOCNR	Flo Corner Seater Standard Back	780	710	710	450	500	3
FLO1A	Flo 1 Seater Standard Back With Arms	780	780	710	450	500	4
FLO2A	Flo 2 Seater Standard Back With Arms	780	1380	710	450	500	4.7
FLO2.5A	Flo 2.5 Seater Standard Back With Arms	780	1580	710	450	500	5.2
FLO3A	Flo 3 Seater Standard Back With Arms	780	1980	710	450	500	5.9
FLO4A	Flo 4 Seater Standard Back With Arms	780	2580	710	450	500	9.8
FLOOTTO710600	Flo Ottoman 710 x 600	450	600	710	450	710	2
FLOOTTO710710	Flo Ottoman 710 x 710	450	710	710	450	710	2
FLOSBHUD7S	Flow Standard Huddle - 7 Seater	780	2670	2560	450	500	17.1
FLOSBHUDA7S	Flow Standard Huddle - w/ Arms - 7 Seater	780	2670	2650	450	500	18.9

Flo Standard Range

Fabric A Fabric B Fabric C

PROUDLY AUSTRALIAN MADE



1 Seater Standard Back
FL01

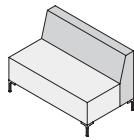

2 Seater Standard Back
FL02

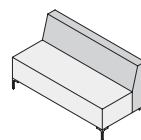

2.5 Seater Standard Back
FL02.5

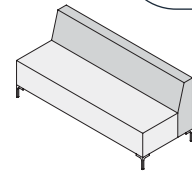

3 Seater Standard Back
FL03

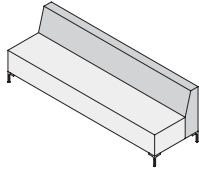

4 Seater Standard Back
FL04

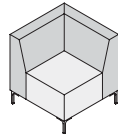

Flo Corner Seater Standard Back
FL0CNR

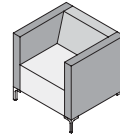

Flo 1 Seater Standard Back
with arms
FL01A

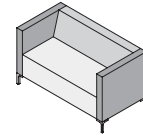

Flo 2 Seater Standard Back
with arms
FL02A

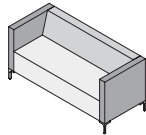

Flo 2.5 Seater Standard Back
with arms
FL02.5A

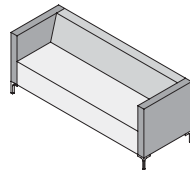

Flo 3 Seater Standard Back
with arms
FL03A

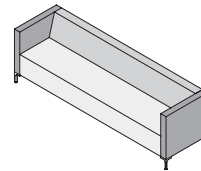

Flo 4 Seater Standard Back
with arms
FL04A

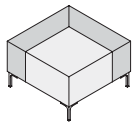

Flo Ottoman 710 x 710
FL00TT0710710

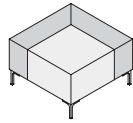

Flo Ottoman 710 x 710
FL00TT0710710

Configuration Options



Huddle - 7 Seater
FLOSBHUD7S



Huddle - 7 Seater - With Arms
FLOSBHUDA7S

Note: Custom two-tone upholstery orders (outside the standard two-tone specifications) may incur an additional charge.

Flo Tall

For added privacy, extra back and neck support, and comfort, the Flo is also available in a tall version. The height of the back provides a semi-enclosed, cocoon type working environment enabling persons to have 'their own space' amongst a busy workplace. The taller version is ideal for activities requiring heightened focus and concentration, or even phone discussions.

Feature Highlights

- Large range of modular configuration options
- Options to add rectangular shaped arms and matching ottoman
- Modern design with 120mm high feet



2 Seater

Flo Tall

Code	Description	External (mm)			Seat (mm)		Meterage
		Height	Width	Depth	Height	Depth	
FLO1STB	Flo 1 Seater Tall Back	1200	600	710	450	500	3.2
FLO2STB	Flo 2 Seater Tall Back	1200	1200	710	450	500	4.6
FLO2.5STB	Flo 2.5 Seater Tall Back	1200	1500	710	450	500	5.4
FLO3STB	Flo 3 Seater Tall Back	1200	1800	710	450	500	6.4
FLO4STB	Flo 4 Seater Tall Back	1200	2400	710	450	500	9.2
FLOCNRTB	Flo Corner Seater Tall Back	1200	710	710	450	500	4.6
FLO1STBA	Flo 1 Seater Tall Back With Arms	1200	780	710	450	500	6.6
FLO2STBA	Flo 2 Seater Tall Back With Arms	1200	1380	710	450	500	8.0
FLO2.5STBA	Flo 2.5 Seater Tall Back With Arms	1200	1580	710	450	500	8.8
FLO3STBA	Flo 3 Seater Tall Back With Arms	1200	1980	710	450	500	9.8
FLO4STBA	Flo 4 Seater Tall Back With Arms	1200	2580	710	450	500	12.6
FLO0TTO710600	Flo Ottoman 710 x 600	450	600	710	450	710	2
FLO0TTO710710	Flo Ottoman 710 x 710	450	710	710	450	710	2
FLOTBHUD7S	Flow Tall Huddle - 7 Seater	1200	2670	2560	450	500	26.6
FLOTBHUDA7S	Flow Tall Huddle - With Arms - 7 Seater	1200	2670	2650	450	500	30

Flo Tall Range

Fabric A Fabric B Fabric C

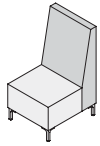

1 Seater Tall Back
FL01STB

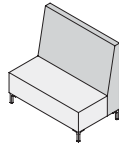

2 Seater Tall Back
FL02STB

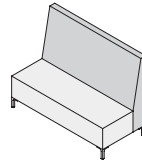

2.5 Seater Tall Back
FL02.5STB

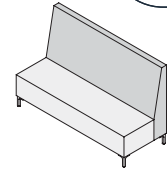

3 Seater Tall Back
FL03STB

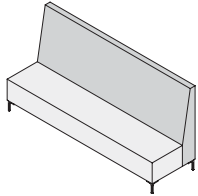

4 Seater Tall Back
FL04STB

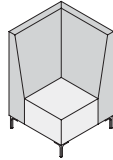

Flo Corner Seater Tall Back
FL0CNRB

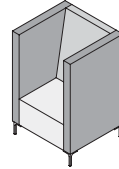

Flo 1 Seater Tall Back with arms
FL01STBA

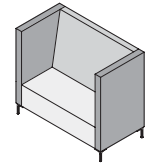

Flo 2 Seater Tall Back with Arms
FL02STBA

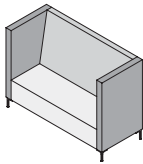

Flo 2.5 Seater Tall Back with Arms
FL02.5STBA

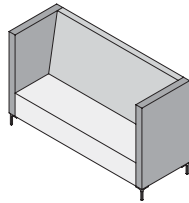

Flo 3 Seater Tall Back with Arms
FL03STBA

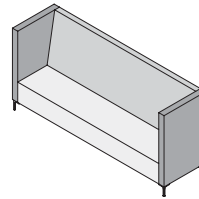

Flo 4 Seater Tall Back with Arms
FL04STBA

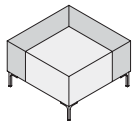

Flo Ottoman 710 x 710
FL00TT0710710

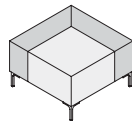

Flo Ottoman 710 x 710
FL00TT0710710

Configuration Options



Huddle - 7 Seater
FL0TBHUD7S



Huddle - 7 Seater - With Arms
FL0TBHUA7S

Note: Custom two-tone upholstery orders (outside the standard two-tone specifications) may incur an additional charge.

Zig

The Zig presents a large range of angular lounges suitable for office breakout zones, team collaboration spaces and reception areas. The striking appearance of the Zig will create instant style and add interest in any office setting. Offering a unique and modular design, the lounge structure allows for endless configuration options. The addition of optional matching ottomans completes the space.

Feature Highlights

- Large range of modular configuration options
- Options to add matching ottoman
- Standard lead-time is 5-6 weeks from the order date



1 Seater 1350W Back

Zig

Code	Description	External (mm)			Seat (mm)		Meterage
		Height	Width	Depth	Height	Depth	
ZIG675OTTO	Zig Ottoman 675	450	675	585	450	585	1.5
ZIG1350OTTO	Zig Ottoman 1350	450	1350	585	450	585	2
ZIG1S675	Zig 1 Seater with 675W Back	850	675	585	450	585	1.7
ZIG1S1350	Zig 1 Seater with 1350W Back	850	1350	585	450	585	3.8
ZIG2S675	Zig 2 Seater with 675W Back	850	1350	585	450	585	3.2
ZIG2S675RA	Zig 2 Seater with 675W Back & RH Arm	850	1350	585	450	585	3.9
ZIG2S675LA	Zig 2 Seater with 675W Back & LH Arm	850	1350	585	450	585	3.9
ZIG3SCONFIG	Zig 3 Seater Configuration	850	2070	1800	450	585	11.7
ZIG2SCONFIG	Zig 2 Seater Configuration	850	2400	585	450	585	7.8
ZIG2.5SCONFIG	Zig 2.5 Seater Configuration	850	2470	585	450	585	9.5
ZIG3SHCONFIG	Zig 3 Seater Hexagon Configuration	850	2740	1210	450	585	11.4
ZIG5SHCONFIG	Zig 5 Seater Hexagon Configuration	850	2740	2380	450	585	19
ZIG3SOTCONFIG	Zig 3 Seater Configuration with Ottoman	850	2740	1800	450	585	13.2
ZIG5SCONFIG	Zig 5 Seater Configuration	850	3410	1800	450	585	17.3

Zig Range

Fabric A Fabric B



Zig Ottoman 675
ZIG6750TTO

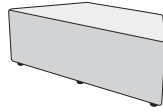

Zig Ottoman 1350
ZIG13500TTO

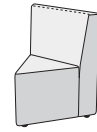

Zig 1 Seater with 675W Back
ZIG1S675

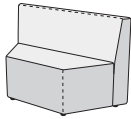

Zig 1 Seater with 1350W Back
ZIG1S1350

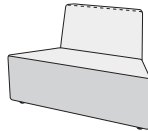

Zig 2 Seater with 675W Back
ZIG2S675

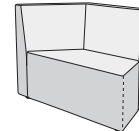

Zig 2 Seater with 675W Back - Right Arm
ZIG2S675RA

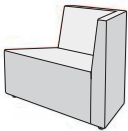

Zig 2 Seater with 675W Back - Left Arm
ZIG2S675LA

Configuration Options



Zig 3 Seater Configuration
ZIG3SCONFIG



Zig 2 Seater Configuration
ZIG2SCONFIG



Zig 2.5 Seater Configuration
ZIG2.5SCONFIG



Zig 3 Seater Hexagon Configuration
ZIG3SHCONFIG



Zig 5 Seater Hexagon Configuration
ZIG2SCONFIG



Zig 3 Seater Configuration-with Ottoman
ZIG3SOTCONFIG



Zig 5 Seater Configuration
ZIG5SCONFIG

Note: Custom two-tone upholstery orders (outside the standard two-tone specifications) may incur an additional charge.

Harper

The exceptional design of the Harper Lounge offers a comfortable individual and shared working space in the office. Select from a range of configuration options to suit the specific working requirements. The enclosed structure of the Harper Booth is ideal for focused team work and private meetings.

Feature Highlights

- Comfortable internal cushion
- Lounges available in 1 seater, 2 seater and 2.5 seaters
- 4 Seater Booth; 2.5 seater lounges combined with a Silhouette table base and worktop
- Add GPO to front panel of the lounge
- Two-tone fabric option; select from house fabric range or BYO fabric to match any colour scheme
- 150mm high foot



1 Seater Lounge

Harper

Code	Description	External (mm)			Seat (mm)		Meterage
		Height	Width	Depth	Height	Depth	
HARP1STB	Harper 1 Seater Lounge	1400	1050	750	450	500	7.5
HARP2STB	Harper 2 Seater Lounge	1400	1650	750	450	500	9
HARP2.5STB	Harper 2.5 Seater Lounge	1400	1950	750	450	500	11
HARPBOOTH	Harper 4 Seater Booth; 2 x 2.5 Seater Lounges, 500mmDIA Silhouette Table Base with 1200w x 500d Worktop	1400	1950	2200	450	500	24

Prices exclude installation. Harper Booth includes two hobtop brackets, assembly required on site. Option to powdercoat feet at an additional cost of \$100ex GST per lounge. Select from Standard 25mm Melamine range for worktop. Includes two radius corners on worktop.



PROUDLY AUSTRALIAN MADE



2 Seater Lounge



2.5 Seater Lounge



4 Seater Booth



4 Seater Booth Top View

Harper Range

Fabric A Fabric B



Harper 1 Seater Tall Back
HARP1STB



Harper 2 Seater Tall Back
HARP2STB



Harper 2.5 Seater Tall Back
HARP2.5STB



Harper 4 Seater Booth
HARPBOOTH

Note: Custom two-tone upholstery orders (outside the standard two-tone specifications) may incur an additional charge.

Archer

For employees to knuckle down and focus on some serious individual work, they require a level of quietness and privacy – things that can be hard to come by in a busy open-plan office. Enter the Archer series. Australian-made and boasting a ten-year warranty, this simple yet sophisticated range offers employees inviting, semi-private focus pods where they can work uninterrupted.

Constructed from high quality melamine, the Archer Worktop comes in three different sizes, an impressive range of colours and its rear scallop provides plenty of space for cables.

Feature Highlights

- Straightforward design makes it easy to assemble
- Available in a range of colours and fabrics to suit any style or brand
- Quality backed by a 10-year warranty
- Made in Australia to the strictest industry standards
- Quick to manufacture and deliver – order now for installation in four weeks



Standard Screen Height

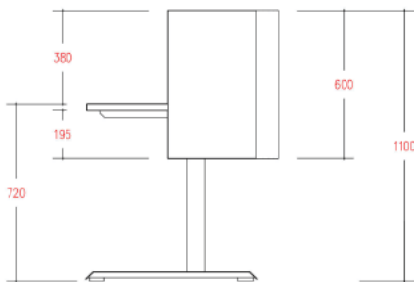

Archer Focus Screen 600H X 1280W X 450D - Imperial

Archer Focus Screen

Code	Description	Fabric Meterage	Height (mm)	Width (mm)	Depth (mm)
ARCD06124	Archer Focus Screen	2.5	600	1280	450
ARCD06154	Archer Focus Screen	3.0	600	1580	450
ARCD06184	Archer Focus Screen	3.5	600	1880	450

(includes 2 x small worktop brackets & 2 x return brackets)



Archer Worktops Range

Archer Worktop 1200 X 750 Scallop

Archer Worktop 1500 X 750 Scallop

Archer Worktop 1800 X 750 Scallop



Archer Worktops

Code	Description	Width (mm)	Depth (mm)	Melamine Colours	Features
ARCWT1207	Archer Worktop	1200	750	Standard Melamine Range	Includes scallop and radius to rear corners of worktop
ARCWT1507	Archer Worktop	1500	750	Standard Melamine Range	Includes scallop and radius to rear corners of worktop
ARCWT1807	Archer Worktop	1800	750	Standard Melamine Range	Includes scallop and radius to rear corners of worktop

Note: * Archer Focus Screens adjusted to suit Archer Worktop sizes.

* Meterage provided is based on **chair** fabric (137cmW). Please note, less meterage would be required if supplying **screen** fabric (188cmW).

Laptop Table

The new Laptop Table has been designed specifically to complement the Activity Based Working product range. Select from a range of different worktop shapes and standard melamine finishes to match the desired colour scheme.

Feature Highlights

- Black Powdercoat Stand
- Easy to move around and adjust position as required
- Select from standard melamine colour range
- Square 18mm worktop; or Square 18mm Worktop with 60mm radius corners
- 700mmH x 350mmW x 350mmD
- Australian made
- 5-6 week lead-time



LAPTOP-SQ

LAPTOP-SQ-RAD

Laptop Table

Code	Description	External (mm)			Finishes
		Height	Width	Depth	
LAPTOP-SQ	Laptop Table - Square 18mm Worktop	700	350	350	Black Powdercoat / Standard Melamine Range
LAPTOP-SQ-RAD	Laptop Table - Square 18mm Worktop with 60mm Radius Corners	700	350	350	Black Powdercoat / Standard Melamine Range



PROUDLY
AUSTRALIAN
MADE



Image features Zig Lounges with Ottoman

House Colour Ranges

The **Caprio** fabric range offers a sense of style, elegance and awe. The Caprio is a high performance textile suitable for heavy commercial applications.



Ashville



Coal



Oatmeal



Pebble

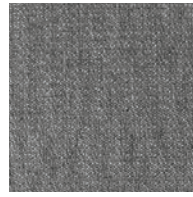

Storm

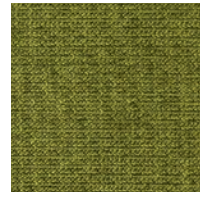

Citron



Fudge



Papaya



Sky

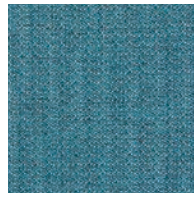

Turquoise

Note: Due to many factors, but not limited to the following: customer monitor calibration and printing processes colours represented within this brochure are indicative only. Please request a sample swatch if unsure about colour accuracy.



The **Cashmere** fabric range, by Wortley Group, is a beautifully soft, textured plain woven in 100% Polyester. Featuring a lightly brushed surface, Cashmere is a soft yet high performance textile suitable for commercial applications.



Dove



Silver Dust



Pebble



Almond



Imperial



Pimento



Leaf



Marigold



Nero

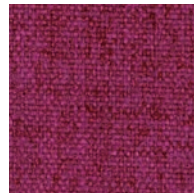

Azalea



Purple



Peacock

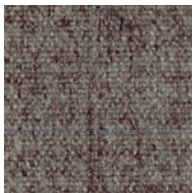

Haze

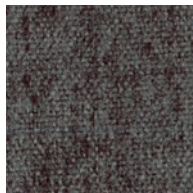

Pewter



Mineral

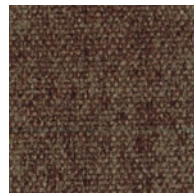

Walnut







PROUDLY
AUSTRALIAN
MADE





Embrace the modern
day workplace and
activity-based
working today.